

SECTION III

SECTION III

APPENDICES

ANNEXES

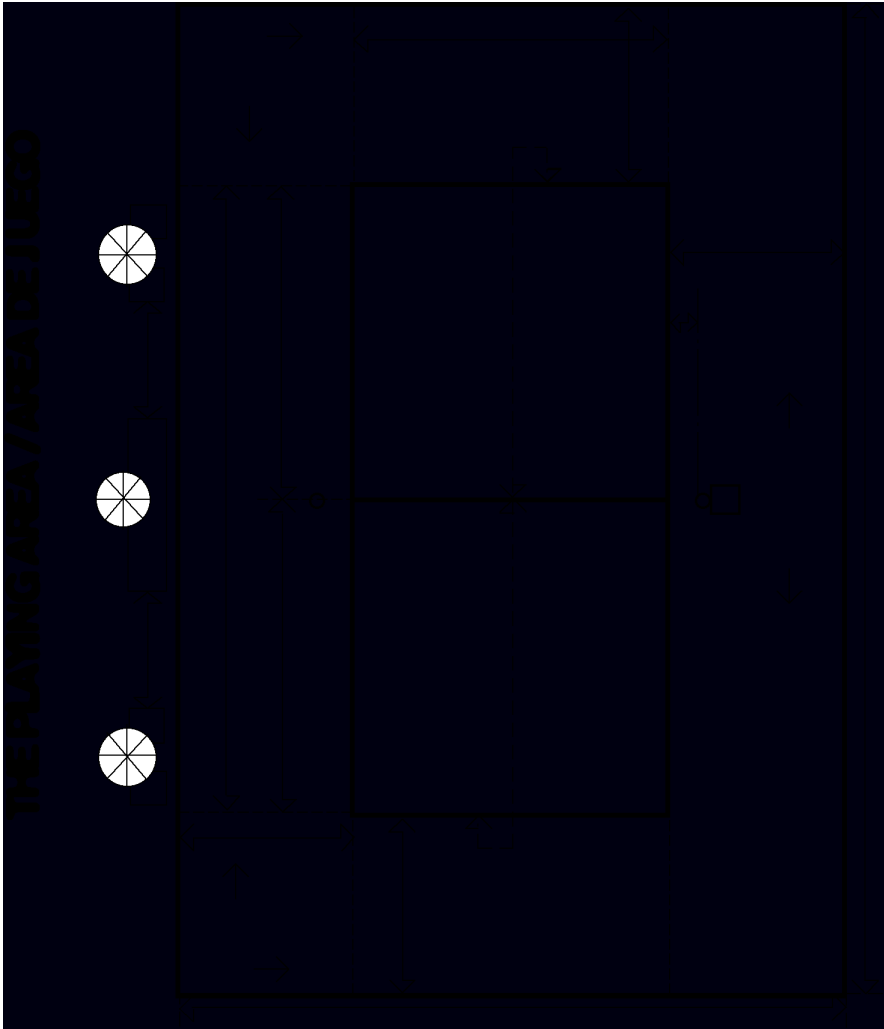

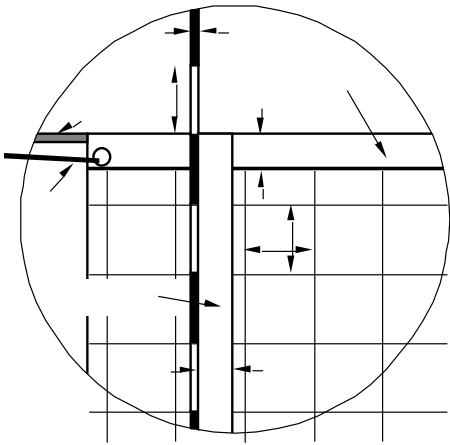
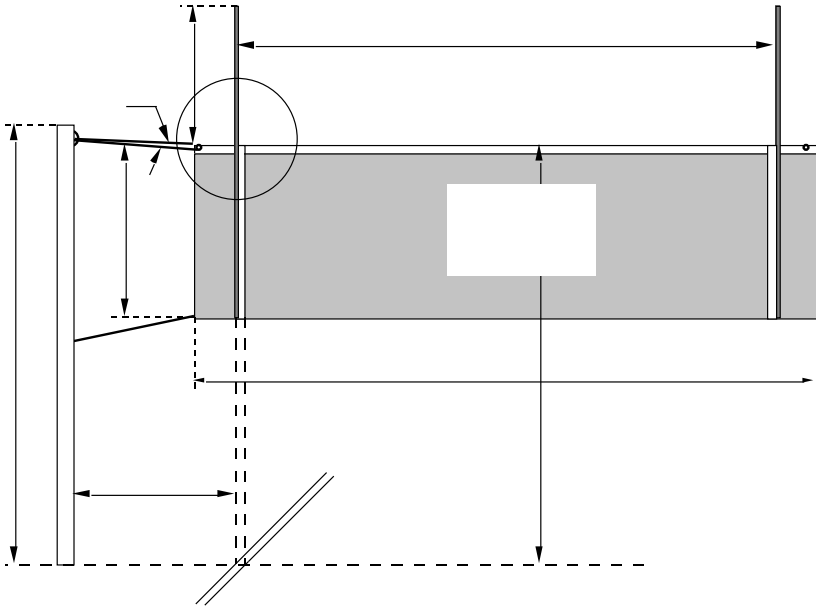

BALL CROSSING THE VERTICAL PLANE OF THE NET
 BALLON TRAVERSANT LE PLAN VERTICAL DU FILET

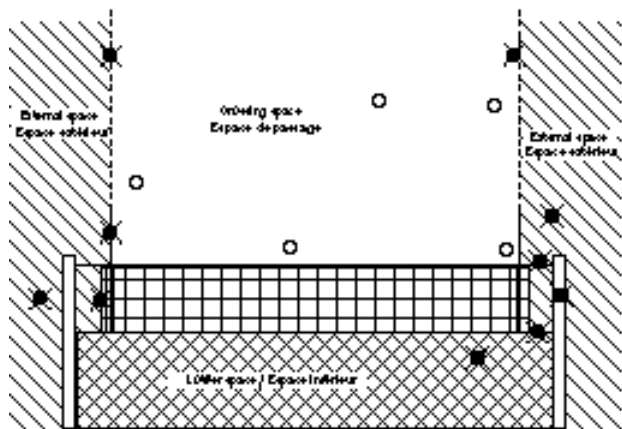

- = Fault / Faute
- = Correct crossing / Passage correct

SCREEN ECRAN

Diagram 4 / Fig. 4 - R.16.6

- - Screen
- - Correct

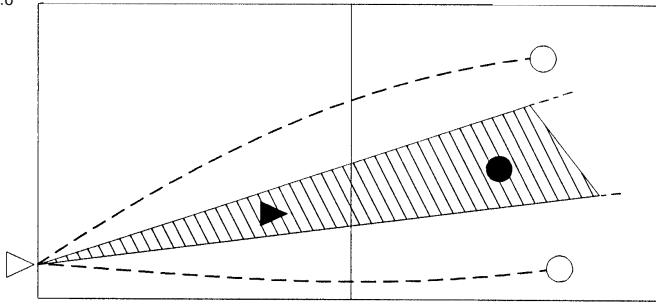

COMPLETED BLOCK BLOC EFFECTIF

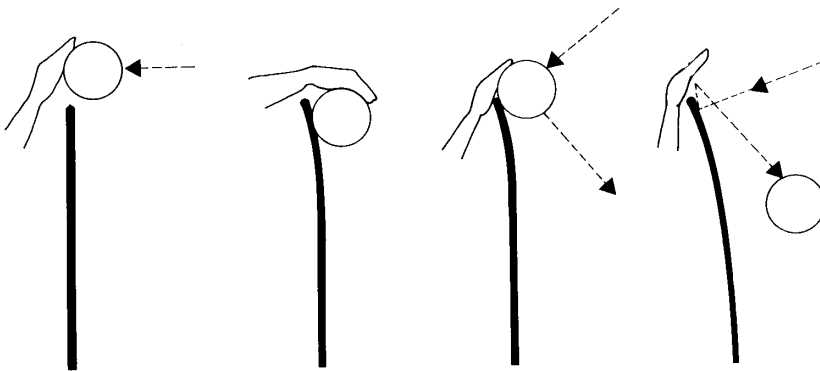

Ball above the net

Ball lower than the top of the net

Ball touches the net

Ball bounces off the net

Le ballon est au-dessus du filet

Le ballon est en-dessous du bord supérieur du filet

Le ballon touche le filet

Le ballon rebondit sur le filet

Diagram 5 / Fig. 5 R.18.1

LOCATION OF THE REFEREEING CORPS AND THEIR ASSISTANTS
 EMBLEMENT DU CORPS ARBITRAL ET DE LEURS ASSISTANTS

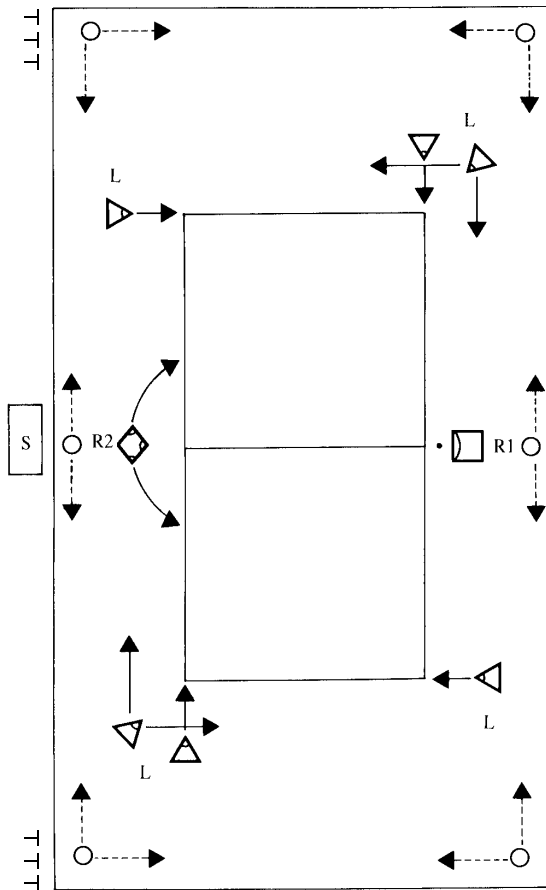

- R1 = First referee / Premier arbitre
- R2 = Second referee / Second arbitre
- S = Scorer / Marqueur
- L = Linesjudge / Juges de ligne
- O = Ball retrievers / Ramasseurs de ballon
- T = Sand Levelers/ Egaliseurs de sol

Diagram 6 / Fig. 6 - R.3.3, 25 - 28





MISCONDUCT SANCTION SCALE

Categories	Times	Sanction	Cards to Show	Consequence
1. Unsportsmanlike conduct	First	Warning	Yellow	Prevention no penalty
	2 and subs.	Penalty	Red	Loss of rally
2. Rude conduct	1 and subs	Penalty	Red	Loss of rally
(Format "A") 3. Offensive conduct	First	Disqualification	Both-Seperately	Team declared incomplete for the match, loss of match
(Format "B") 3. Offensive conduct	First	Expulsion	Both-Together	Team declared incomplete for the set, loss of set
4. Aggression	First	Disqualification	Both-Seperately	Team declared incomplete for the match, loss of match

ECHELLEDESSANCTIONSPOURMAUVAISECONDUITE

Catégories	Fois	Sanction	Cartons à montrer	Conséquence
1. Conduite anti-sportive	1ère fois	Avertissement	Jaune	Avertissement pas de pénalité
	2 et suiv.	Pénalisation	Rouge	Perte de l'échange de jeu
2. Conduite grossière	1 et suiv.	Pénalisation	Rouge	Perte de l'échange de jeu
(Format "A") 3. Conduite injurieuse	1ère fois	Disqualification	les deux séparément	Equipe déclarée incomplète pour le match, perte du match.
(Format "B") 3. Conduite injurieuse	1ère fois	Expulsion	les deux ensemble	Equipe déclarée incomplète pour le set, perte du set.
4. Aggression	1ère fois	Disqualification	les deux séparément	Equipe déclarée incomplète pour le match, perte du match.

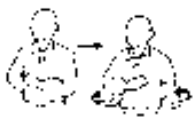
Diagram 9 / Fig. 9 R. 23





Situations to be indicated	Hand signals to be executed by		Gestes à exécuter par	Faits à signaler
	First referee	Second referee		
Authorisation to serve R. 16.4	F		1  Déplacer la main pour indiquer la direction du service	Autorisation de servir R. 16.4
Team to serve R. 7.3 R. 24.2.3.c	F S		2  Étendre le bras du côté de l'équipe qui devra servir	Equipe au service R. 7.3 R. 24.2.3.c
Change of courts R. 22.1	F S		3  Lever les avant-bras en avant et en arrière, et les tourner autour du corps	Changement de terrain R. 22.1
Time-out R. 19.3	F S		4  Poser la paume d'une main sur les doigts de l'autre, tenue verticalement (forme du T)	Temp-mort R. 19.3
Delay warning R. 20.2.1 Delay penalty R. 22.2.2	F		5  Pointer le poignet avec le carton jaune (avertissement) ou rouge (pénalisation)	Avertissement pour retard de jeu R. 20.2.1 Pénalisation pour retard de jeu R. 22.2.2

REFEREES' OFFICIAL HAND SIGNALS

Diagram 7, 6 to 10

GESTES OFFICIELS DES ARBITRES

Fig 7, 6 à 10





Situations to be indicated	Hand signals to be executed by		Gestes à exécuter par	Faits à signaler
	First referee	Second referee		
Misconduct/warning R. 22.2.1 or penalty R. 22.2.2	F	S	6  Montrer une carte jaune pour l'avertissement et rouge pour la pénalisation	Conduite incorrecte avertissement R. 22.2.1 ou pénalisation R. 22.2.2
Expulsion R. 22.2.3	F	S	7  Montrer les deux cartes ensemble pour l'expulsion.	Expulsion R. 22.2.3
Disqualification R. 22.2.4	F	S	8  Montrer les deux cartes séparément pour la disqualification	Disqualification R. 22.2.4
End of set (or match) R. 7.1 R. 7.2	F	S	9  Croiser les avant bras devant la poitrine, les mains ouvertes.	Fin du set (ou match) R. 7.1 R. 7.2
Ball not tossed or released at the service hit R. 16.5.4	F	S	10  Lever le bras tendu, la paume de la main vers le haut.	Ballon non lancé ou lâché pendant la frappe de service. R. 16.5.4

REFEREES' OFFICIAL HAND SIGNALS

Diagram 7, 11 to 15

GESTES OFFICIELS DES ARBITRES

Fig 7, 11 à 15





Situations to be indicated	Hand signals to be executed by		Gestes à exécuter par	Faits à signaler
	First referee	Second referee		
Delay in service R.15.5.3	F		11 	Retard dans le service. R. 15.5.3
Screening R. 16.6	F S		12 	Ecran R. 16.6
Ball touched R. 11.3	F S		13 	Ballon touché. R.11.3
Ball "in" R. 11.3	F S		14 	Ballon "dedans" (in) R.11.3
Ball "out" R. 11.4	F S		15 	Ballon "dehors" (out) R. 11.4

REFEREES' OFFICIAL HAND SIGNALS

Diagram 7, 16 to 20

GESTES OFFICIELS DES ARBITRES

Fig. 7, 16 à 20



Situations to be indicated	Hand signals to be executed by		Gestes à exécuter par	Faits à signaler
	First referee	Second referee		
Held ball R. 13.5.3	F	S	 <p>Slowly lift the forearm, palm of the hand facing upwards.</p>	Ballon tenu R. 13.5.3
Double contact R. 13.5.4	F S	S	 <p>Raise two fingers, spread open.</p>	Double touche R. 13.5.4
Four hits R. 13.5.1	F S	S	 <p>Raise four fingers, spread open.</p>	Quatre touches R. 13.5.1
Net touched by a player or a served ball R. 15.4.3 R. 16.8.b	F S	S	 <p>Touch the top of the net or its side, according to the fault.</p>	Filet touché par un joueur ou le ballon du service R. 15.4.3 R. 16.8.b
Reaching beyond the net R. 15.4.1	F	S	 <p>Place a hand above the net, palm facing downwards.</p>	Franchissement par dessus le filet R. 15.4.1



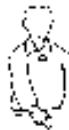

REFEREES' OFFICIAL HAND SIGNALS

Diagram 7, 21 to 23

GESTES OFFICIELS DES ARBITRES

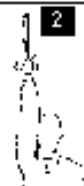
Fig. 7, 21 à 23

Situations to be indicated	Hand signals to be executed by		Gestes à exécuter par		Faits à signaler
	First referee	Second referee	F	S	
Attack-hit fault R.17.2.3 R.17.2.5 or on the opponent's service R.17.2.4	F	S		21 Effectuer un mouvement de haut en bas avec l'avant-bras, la main ouverte.	Faute d'attaque R.17.2.3 R.17.2.5 ou sur le service adverse R.17.2.4
Interference by penetration into the opponent's court R.152 R.141.3	F	S		22 Montrer du doigt la ligne centrale.	Interférence par pénétration dans le camp adverse R.152 R.141.3
Double fault and replay R.12.2.3	F			23 Lever verticalement les deux pouces.	Double faute et échange à rejouer R.12.2.3

Situations to be indicated	Flag signals to be executed by		Gestes à exécuter par	Faits à signaler
	Linesjudge	L		
Ball "in" R. 11.3	L		1 Abaisser le fanion.	Ballon "dedans" (in) R. 11.3
Ball "out" R. 11.4	L		2 Lever le fanion.	Ballon "dehors" (out) R. 11.4
Ball touched R. 27.2.1.b	L		3 Lever le fanion et toucher le dessous avec la paume de la main libre.	Ballon touché R. 27.2.1.b
Ball passing outside the crossing space or server's foot fault R. 11.4 R. 16.5.1	L		4 Agiter le fanion au-dessus de la tête et montrer du doigt l'antenne ou la ligne de fond.	Ballon qui traverse en dehors de l'espace de passage ou faute de pied au service. R. 11.4 R. 16.5.1
Judgement impossible R. 16.5.1	L		5 Lever et croiser les deux avant-bras et mains devant la poitrine.	Jugement impossible R. 16.5.1

